

6-Way 16 dB Resistive Power Divider

Data Sheet



DC-6000 MHz
PWR-LINE™

Model: PRS-S6

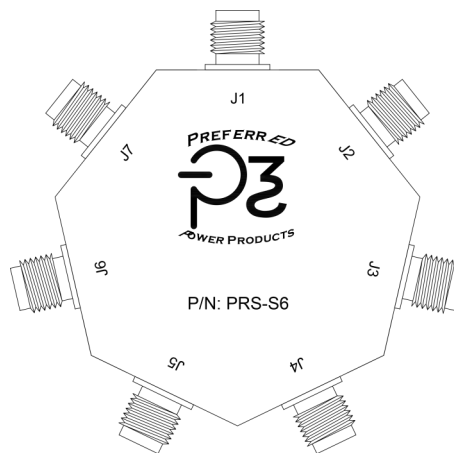

Frequency:	DC - 6000 MHz
Number Of Splits:	6
Power:	2 Watts CW
Amplitude Tracking:	<0.20 dB
Insertion Loss:	16 ±0.50 dB Max.
Phase Tracking:	<4.0°
VSWR:	1.25:1 Max. All Ports
Connectors:	"SMA" Female, All Ports

PRS Series Resistive Power Dividers are precision power splitters that provide excellent equal power division in a matched 50Ω system. With a 2 watt input power capability, **PRS** dividers are well suited for many laboratory and test applications. The compact sealed designs allow operation in a variety of operational environments.

NOTES:

Material: Aluminum Alloy, 6061-T651
 Finish: Blue Paint per MIL-PRF-24712A
 Operating Temperature: -55°C to +85°C
 Other connectors configurations available

Specifications subject to change without notice

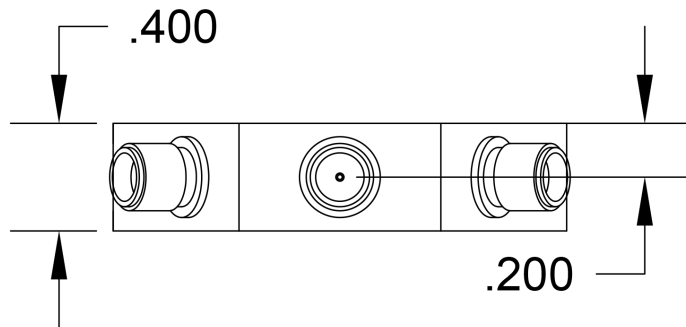
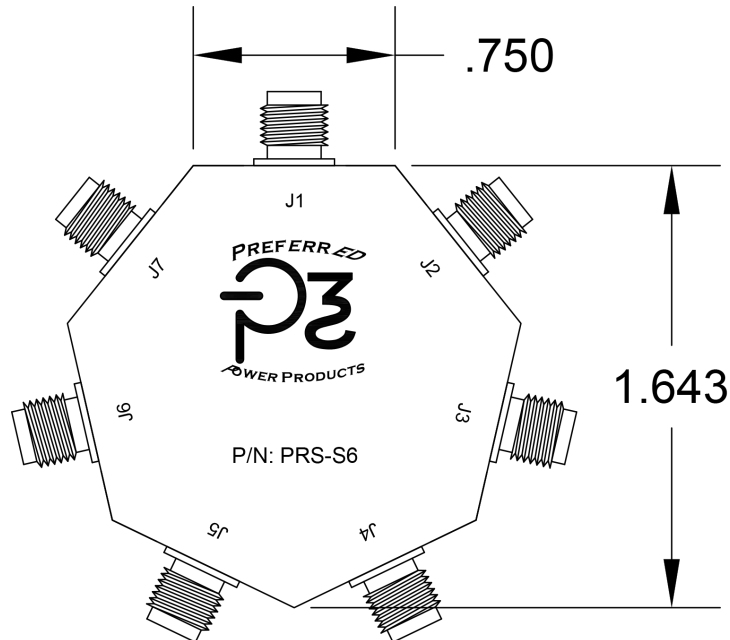

www.preferredpowerproducts.com

Tel: 1-772-291-2549 | sales@preferredpowerproducts.net

STUART, FL 34997